



# FURAGO XD

## INSTRUCTION MANUAL



C-00230 - Manual - 2026-05

- Download the latest version of the manual from [www.corally.com](http://www.corally.com)
- Téléchargez la dernière version du manuel à partir de [www.corally.com](http://www.corally.com)
- Laden Sie die neueste Version des Handbuchs von [www.corally.com](http://www.corally.com) herunter.
- Download de nieuwste versie van de handleiding van [www.corally.com](http://www.corally.com)

<https://corally.com/en/customer-service/downloads-manuals>



LANGUAGES



[WWW.CORALLY.COM](http://WWW.CORALLY.COM)

## INTRODUCTION

Thank you for purchasing a Team Corally car. This manual describes the instructions for using the model and the electronic components. You will also find some tips on how to maintain your RC model so that you can enjoy it for years to come. You have purchased one of the most efficient models available on the market that has been designed by a team of professionals. You will also benefit from the best after-sales support. All Team Corally models guarantee a high quality of manufacture and performance that guarantees you a high satisfaction of use and services provided by the Team Corally. Always take the time to read the instructions carefully in order to follow all the procedures to use your RC model safely for you and for other people and property in the area. This will allow you to take full advantage of all the performance of your RC model.

Please also check the website [www.corally.com/Downloads/](http://www.corally.com/Downloads/) to check if you have the latest version of this instruction manual. (Version: see bottom cover of this manual)

If you have any questions about the model and its components, you can send a message to [support@corally.com](mailto:support@corally.com)

We also recommend that you get help from an experienced model maker or your dealer.

You will find all the references of the spare parts on the website [www.corally.com](http://www.corally.com)

## TERM OF USE

The user is responsible for the use of your model. The user assumes all risks associated with the use of the model. This model is not intended for use by children under 14 years of age without the supervision of a responsible adult who is familiar with the dangers of using a RC model. Team Corally / JSP Group Intl bvba, its manufacturers, distributors and resellers cannot control the use and load of the model and therefore cannot be held responsible for any damage to property and damage caused to persons resulting from the use of this product. You must accept these conditions and consider yourself fully responsible for the use of this product. If not, do not use this product.

Due to the continuous development of our products, the exact specifications of the kit may vary. If you have a problem with your new kit, please contact the store where you purchased it, indicating the part number(s).

Team Corally / JSP Group Intl bvba reserves the right to change any specification without notice. All rights reserved.

## READ FIRST

This owner's manual is designed for use with your vehicle and contains the instructions you will need to operate and maintain your vehicle.

- We know you want to start driving immediately after unpacking, but it is very important that you take the time to read this manual carefully, even if you are an experienced R/C driver.
- Read carefully and follow all instructions in this manual. Failure to comply with the instructions will be considered as abuse and/or negligence which may result in the cancellation of the warranty.
- Your vehicle is designed to operate on uneven terrain. However, dust, sand, water and carpet fibres can get into your car's workspaces and can damage your vehicle if they are not removed quickly. We do not guarantee any warranty on your vehicle against damage caused by external elements such as sand, dirt or water. Users are responsible for the maintenance and safe operation of this vehicle.
- This product is not a toy. It is not suitable for users under 14 years of age, unless they are supervised by adults.
- Never attempt to disassemble electronic components. These have been carefully calibrated at the factory.
- Only improve your car with parts made for your car. If you upgrade performance, replace the entire system (such as the motor, inverter, battery, etc.) so that all components are properly adapted. Any malfunction resulting from a custom modification will void your warranty.
- Before driving your vehicle, please read this manual in its entirety and examine your vehicle and radio control system for any defects.
- For better performance, some adjustments may be necessary.
- This vehicle requires a battery (included in the car or in the packaging). Make sure the vehicle's battery is sufficiently charged before driving, otherwise you may lose control of the vehicle.
- The radio transmitter requires 4 AA batteries (not included)
- Always remove or disconnect the battery from the vehicle to the inverter when not in use.
- Please drive your car in a spacious place. Never drive your car on the street or in traffic. Public places are subject to specific legislation by country, city, municipality, please comply with the legislation for the use of RC models in your region.
- This product is fully assembled in the factory. We accept no liability for damage and/or accidents resulting from custom modifications and/or malfunctions.

## USE PRECAUTIONS

Failure to operate your model in a safe and responsible manner may result in injury to yourself, others or damage to property around you.

- Do not use your model on public roads or in areas where you may encounter pedestrians or riders.
- Do not operate in a congested area or in crowds.
- Do not operate in areas where loud noises can disturb others, such as hospitals and residential areas.
- Do not operate your model with obstructed line of sight, at night or near water.
- Your model is radio controlled, it is subject to possible radio interference. Radio interference can cause loss of control of your model. Be careful.
- Take care not to injure yourself while using tools to adjust or upgrade your model.
- Since the model contains small parts, keep out of reach of children while assembling and/or disassembling your model.
- If your model becomes stuck against an object, release the throttle and retrieve it by hand
- Do not continue to apply the throttle when your model is stuck. This may damage the motor and/or ESC/Receiver unit.
- Turn OFF your model and don't use it if it runs erratically. Please do not use your model again until the problem has been solved.
- Keep the wheels of the model off the ground when checking the operation of the radio equipment.
- When learning to operate your model, go to an area that has no obstacles that can damage your model.
- Before and after each use, check all the screws on the model.
- To maintain the best performance, check that all moving parts move freely.

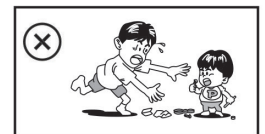
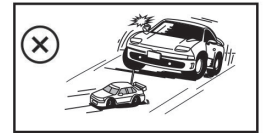

**Take all necessary precautions before, during and after using your model. You are responsible for the safe assembly, maintenance and use of your model.**

**In case of any questions, contact your local reseller or contact Team Corally support for assistance.**

**WARNING: This is not a toy. Not suitable for children under 14 years.**

## NOTICE

All instructions, warranties and other collateral materials are subject to change at Corally's sole discretion. For up-to-date product documentation, visit [www.corally.com](http://www.corally.com) and click on the 'Customer Service' or 'Legal Information' tab for that product at the bottom of the screen.

This manual is an edition of Corally, a division of JSP GROUP INTL nv, Geelseweg 80, B-2250 Olen, Belgium. This manual is protected by a copyright and nothing from this edition may be reproduced or used without any prior written authorisation. Whilst every effort has been made to ensure the accuracy of the information in this manual, errors creep in and Corally can accept no responsibility for failures, wrong specifications, accuracy of colours, losses or damages caused. Corally denies any responsibility claims or damages caused by use of our products. Corally is not responsible for product / parts / specifications / Colour changes or availability of these products.

## LIPO BATTERY SAFETY PRECAUTIONS

- Follow and respect the manufacturer's instructions for use
- It is important to check that your ESC is set to LIPO if you are using a LIPO battery. Failure to comply with this instruction will result in increased battery discharge and may cause fire and damage to persons and property.
- When charging or storing LiPo batteries always use LiPo Safety Bag (Flame retardant).
- Always respect the maximum rate and voltage specified by the battery manufacturer.
- Charge the LIPO battery outdoors or in a ventilated area away from flammable objects and surfaces.
- NEVER leave your LiPo battery unattended while charging.
- If the battery swells during charging, stop charging immediately and disconnect the battery from the charger. Leave the battery outside for a few hours and observe. Then recycle the battery according to the instructions of your country/region. Never dispose of a LIPO battery with domestic waste.
- Before recycling your defective battery, it must be neutralized. Take a plastic container, fill it with water and add a lot of salt until the water becomes opaque. Place the LIPO battery in the water and leave for 24 hours. Check with a voltmeter that the voltage is 0.0V. Then recycle the battery according to local regulations.
- Never charge a damaged or inflated battery.
- Never discharge the battery cells below 3.2V.
- Always use the appropriate balancer/charger when charging your LiPo battery pack.
- When the battery is empty, check the temperature of the battery before charging it. If the battery is very hot, wait until it cools before charging it.
- Never charge a very hot battery as this may cause an explosion or fire.
- When the battery is empty, recharge it immediately. Do not store an empty battery, the battery will continue to discharge, it will fall below the minimum voltage and become unusable.

## SAFETY PRECAUTIONS

For your safety, always use wear gloves and goggles when assembling and maintaining your model.

Always take all necessary precautions when handling products (silicone oil, grease, thread lock, cyanolyte glue, fuel) for the operation of the model. (Refer to the manufacturer's instructions)

For your safety, to keep the warranty and obtain the best performance, always use original CORALLY genuine parts.

Contains: LEAD (CAS 7439-92-1) ANTIMONY (CAS 7440-36-0)

**WARNING:** This product contains a chemical known to the state of California to cause cancer and birth defects or other reproductive harm.

**CAUTION:** CANCER HAZARD

Contains lead, a listed carcinogen. Lead is harmful if ingested. Wash thoroughly after using.

DO NOT use product while eating, drinking or smoking.

**ALL INSTRUCTION MANUALS**

Go to <https://corally.com/en/customer-service/downloads-manuals>

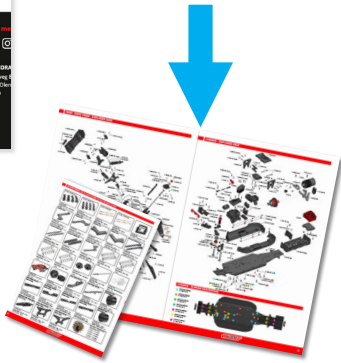
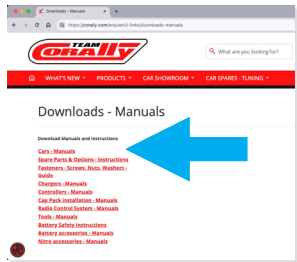
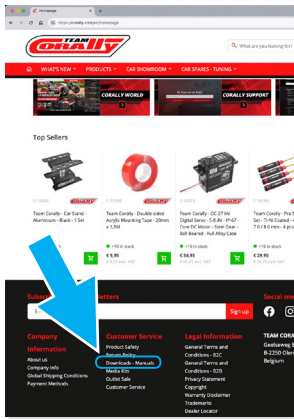

**ONE PAGE MANUALS** (Step by step manual)

Go to <https://world.corally.com/>

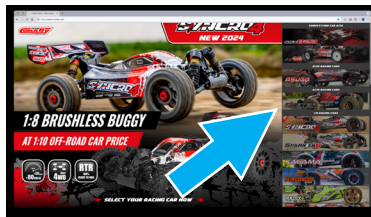

Select your car and visit the showroom

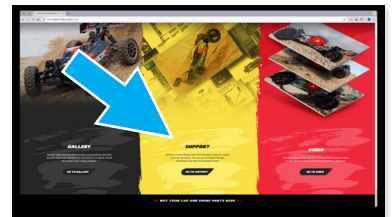

Go to the bottom of the page and click on SUPPORT.

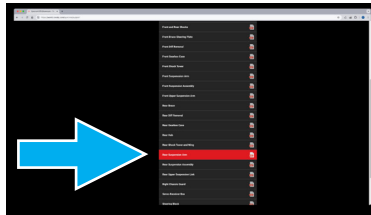

... and select a "One Page Manual"



**KIT CONTENT**



2.4 GHZ Digital Transmitter



RTR Model - Electronics included



Manuals



Pocket Balance Charger

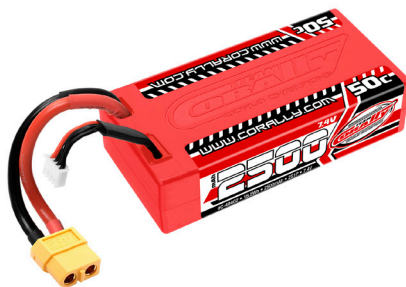

#C-49402 - LiPo Battery 2S - 2500mAh

**REQUIRED FOR OPERATION (Not included)**



4x AA Batteries for the Transmitter

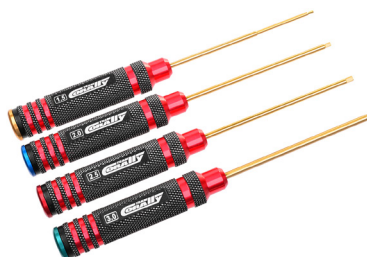

C-16185 Hex Tool Set - 1.5 / 2.0 / 2.5 / 3.0 mm



C-16190 Nut Driver Set - 4.0 / 5.5 / 7.0 / 8.0 mm

## QUICK START GUIDE

### READ THE INSTRUCTIONS



## Instruction

- Lisez les instructions
- Lesen Sie die Anleitung
- Lees de instructies

### CHARGE THE BATTERY



- Chargez la batterie
- Laden Sie den Akku
- De batterij opladen

### INSTALL 4x AA BATTERY - 1.5V



- Respect the polarity
- Respectez la polarité
- Beachten Sie die Polarität
- Respekteer de polariteit
- Installez les piles dans l'émetteur
- Setzen Sie die Batterien in den Sender ein
- Plaats de batterijen in de zender

### MAKE SURE THAT ALL SCREWS AND NUTS ARE TIGHTENED PROPERLY.



- Vérifiez le serrage des vis et écrous
- Überprüfen Sie die Schrauben und Muttern auf festen Sitz
- Controleer de vastheid van de schroeven en moeren

### INSTALL THE BATTERY

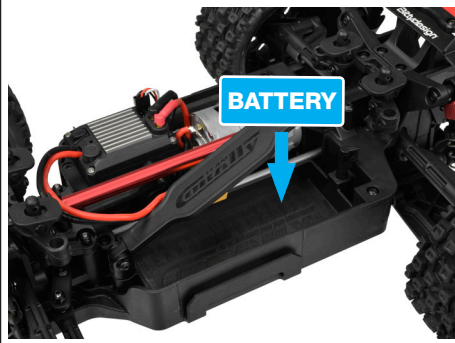

- Installez la batterie chargée
- Setzen Sie den geladenen Akku ein
- Installeer de opgeladen batterij

### TURN ON THE TRANSMITTER (Always First)



- Allumez l'émetteur (Toujours en premier)
- Schalten Sie den Sender ein (Immer zuerst)
- Zet de zender aan (altijd eerst)

### CONNECT THE BATTERY TO THE ESC SWITCH ON THE ESC



- Connectez la batterie au variateur et allumez-le
- Schließen Sie den Akku an den Regler an und schalten Sie ihn ein
- Sluit de accu aan op de regelaar en schakel deze in

### CHECK THE FUNCTIONS

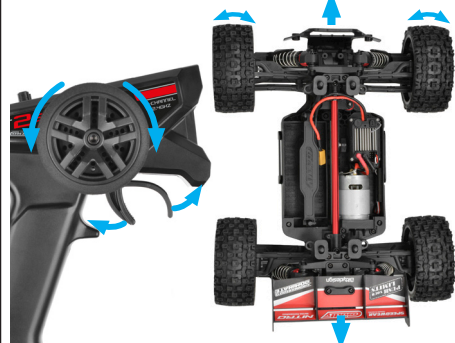

- Contrôlez les fonctions
- Kontrollieren Sie die Funktionen
- Controle van de functies

### CHECK THE RADIO SYSTEM RANGE

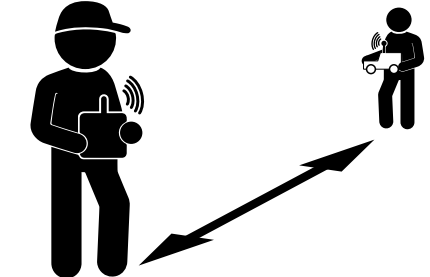

Move away from the max. distance you will drive the vehicle.  
Check that the vehicle responds properly to the controls.  
If not, reduce the distance or change the driving location.

- Contrôlez la portée de l'émetteur
- Überprüfen Sie die Reichweite des Senders
- Controleer het bereik van de zender

### DRIVE SLOWLY TO BEGIN

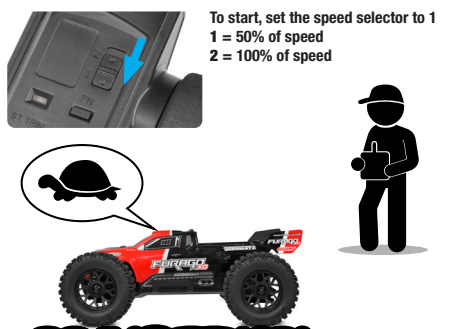

To start, set the speed selector to 1  
1 = 50% of speed  
2 = 100% of speed

- Pour débuter placez le sélecteur de vitesse sur 1
- Um zu beginnen, stellen Sie den Geschwindigkeitswahlschalter auf 1
- Zet om te beginnen de snelheidskeuzeknop op 1

### WHEN FINISHING

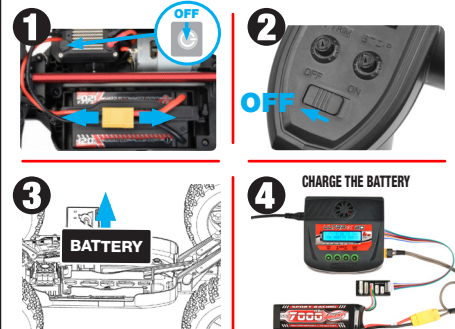

- Après, débranchez la batterie et rechargez-la immédiatement.
- Trennen Sie den Akku ab und laden Sie ihn sofort wieder auf.
- Ontkoppel dan de batterij en laad deze onmiddellijk op.

### CLEAN AND MAINTAIN YOUR VEHICLE



- Nettoyez et entretenez votre voiture !
- Reinigen und pflegen Sie Ihr Auto!
- Reinigen en onderhoud uw auto!

- If your transmitter is no longer controlling the car, you may need to re-pair the transmitter and the car. Please follow the procedure below.
- Si votre émetteur ne pilote plus la voiture, il est peut-être nécessaire de refaire la liaison entre l'émetteur et la voiture. Ci-dessous la procédure.
- Wenn Ihr Sender das Auto nicht mehr steuert, muss die Verbindung zwischen Sender und Auto möglicherweise neu hergestellt werden. Nachfolgend finden Sie die Vorgehensweise.
- Als uw zender de auto niet meer bestuurt, moet u mogelijk de verbinding tussen de zender en de auto opnieuw tot stand brengen. Hieronder vindt u de procedure.



- Press and hold the FN key.
- Appuyez et restez appuyez sur le bouton FN.
- Halten Sie die FN-Taste gedrückt.
- Houd de FN-toets ingedrukt.



- Switch ON the transmitter.
- Allumez l'émetteur.
- Schalten Sie den Sender ein.
- Zet de zender aan.



- The LED is flashing green.
- La LED clignote en vert.
- Die LED blinkt grün.
- Het lampje knippert groen.

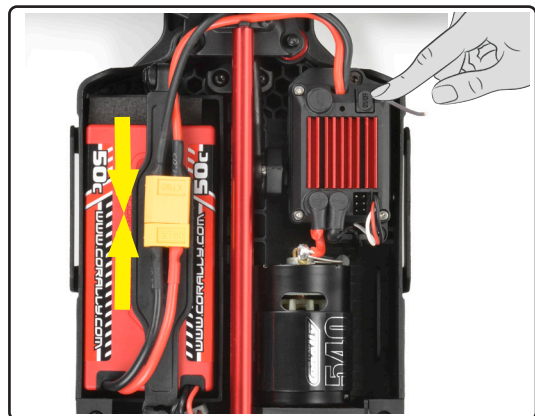

- Connect the battery and press the ON/OFF button.
- Connectez la batterie et appuyez sur le bouton ON/OFF du module de réception.
- Schließen Sie den Akku an und drücken Sie die Ein-/Aus-Taste am Empfangsmodul.
- Sluit de accu aan en druk op de AAN/UIT-knop van de ontvangstmodule.



- The LED has stopped flashing.
- La LED ne clignote plus.
- Die LED blinkt nicht mehr.
- De led knippert niet meer.

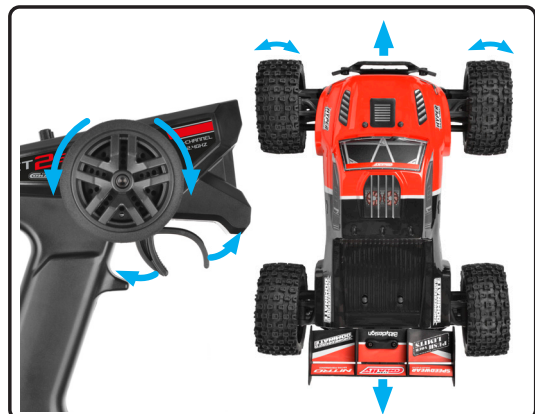

- Check that it is working properly.
- Contrôlez le fonctionnement.
- Überprüfen Sie die Funktion.
- Controleer of alles goed werkt.



**CHARGER - CHARGEUR - LADEGERÄT - LADER**



**LiPo 2S BATTERY CONNECTION**

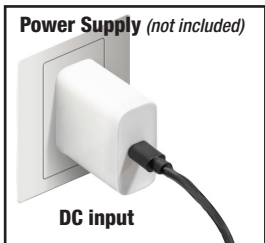

Input Voltage : DC9.0-20.0V@Max 25W  
TYPEC protocol : PD, QC, AFC, SCP

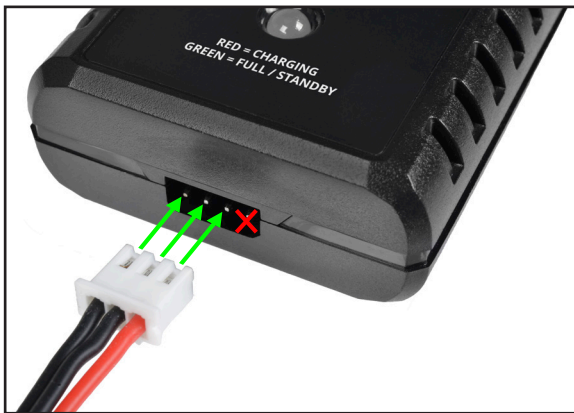

1. Connect the charger power cable to a power supply, the LED light will be lit up to green.

*Branchez le câble d'alimentation du chargeur à une source d'alimentation (non fournie), le voyant LED s'allumera en vert.*

Schließen Sie das Netzkabel des Ladegeräts an eine Stromquelle (nicht im Lieferumfang enthalten) an. Die LED-Anzeige leuchtet grün..

*Sluit de voedingskabel van de lader aan op een stroombron (niet meegeleverd). Het LED-lampje gaat groen branden.*

2. Connect the balance port of the battery to the charger.

**Charging starts automatically once the correct connection has been established and the LED lights up red. The LED lights up green when charging is complete.**

*Connectez le port d'équilibrage de la batterie au chargeur. La charge démarre automatiquement une fois que la connexion correcte a été établie et la LED s'allume en rouge. La LED s'allume en vert lorsque la charge est terminée.*

Verbinden Sie den Ausgleichsanschluss der Batterie mit dem Ladegerät. Der Ladevorgang beginnt automatisch, sobald die richtige Verbindung hergestellt ist und die LED rot leuchtet. Die LED leuchtet grün, wenn der Ladevorgang abgeschlossen ist.

*Sluit de balanspoort van de batterij aan op de lader. Het opladen begint automatisch zodra de juiste verbinding tot stand is gebracht en het LED-lampje rood gaat branden. Het LED-lampje gaat groen branden wanneer het opladen is voltooid.*

**To charge a LiPo 2S battery, connect the connector to the 3 PINs on the left.**

*Pour charger une batterie LiPo 2S, connectez le connecteur aux 3 broches situées à gauche.*

Um einen LiPo 2S-Akku aufzuladen, schließen Sie den Stecker an die 3 Pins auf der linken Seite an.

*Om een LiPo 2S-batterij op te laden, sluit u de connector aan op de 3 pinnen aan de linkerkant.*

**LED STATUS**

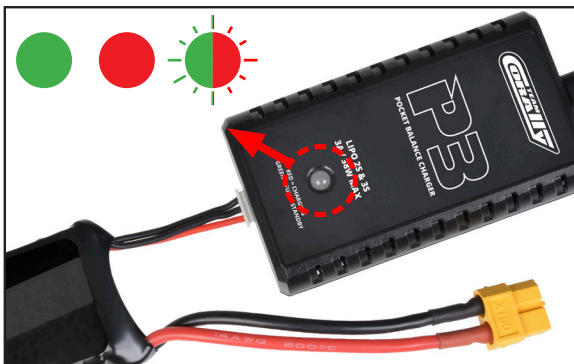

**Green light = Charger in standby mode or the charge is complete.**

*Voyant vert = chargeur en mode veille ou charge terminée.*

Grünes Licht = Ladegerät im Standby-Modus oder der Ladevorgang ist abgeschlossen.

*Groen licht = Oplader in stand-by modus of het opladen is voltooid.*

**Red light = The charge is in progress.**

*Voyant rouge = La charge est en cours.*

Rotes Licht = Der Ladevorgang läuft.

*Rood lampje = Het opladen is bezig.*

**Flashing Red / Green = Error detected (check the battery connection or change to a different power source).**

*Rouge / Vert clignotant = Erreur détectée (vérifiez la connexion de la batterie ou changez de source d'alimentation).*

Blinkt rot/grün = Fehler erkannt (Batterieanschluss überprüfen oder auf eine andere Stromquelle umstellen).

*Knipperend rood/groen = Fout gedetecteerd (controleer de batterijaansluiting of schakel over op een andere stroombron).*



**SHOCK ABSORBER MAINTENANCE - ENTRETIEN DES AMORTISSEURS - STOSSDÄMPFERWARTUNG - ONDERHOUD SCHOKDEMPERS**



It may be necessary to replace the silicone oil in the shock absorbers every 40 runs (depends on how you drive and the type of terrain you drive on).

Il peut être nécessaire de remplacer l'huile silicone des amortisseurs toutes les 40 courses (cela dépend de votre conduite et du type de terrain sur lequel vous roulez).

Es kann notwendig sein, das Silikonöl in den Stoßdämpfern alle 40 Fahrten zu wechseln (abhängig von Ihrer Fahrweise und dem Gelände, auf dem Sie fahren).

Het kan nodig zijn de siliconenolie in de schokdempers om de 40 ritten te vervangen (afhankelijk van uw rijstijl en het soort terrein waarop u rijdt).

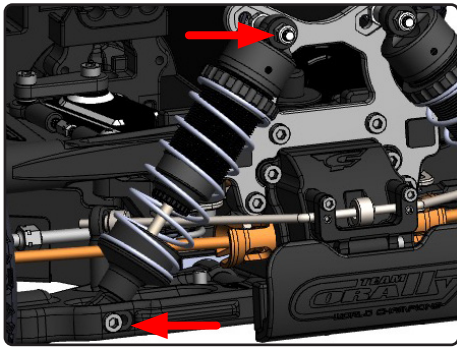

- Remove the shock absorber from the car.
- Démontez l'amortisseur de la voiture.
- Demontieren Sie den Stoßdämpfer vom Auto.
- Demonteer de schokdemper van de auto.

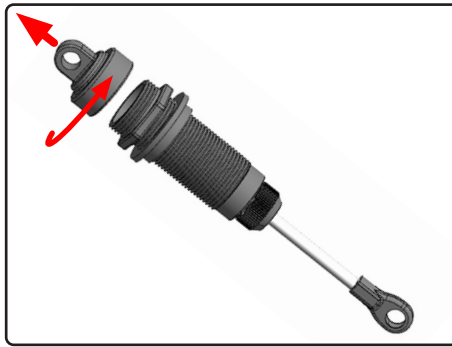

- Unscrew the shock absorber cap.
- Dévissez le capuchon de l'amortisseur.
- Schrauben Sie die Kappe vom Stoßdämpfer ab.
- Schroef de dop van de schokdemper los.

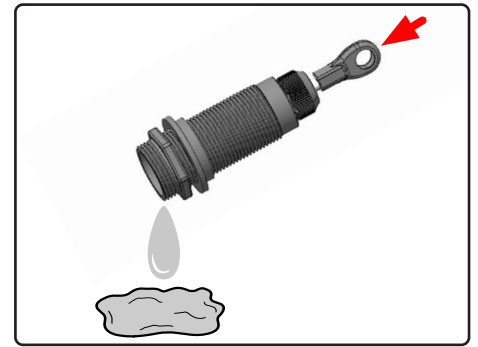

- Drain the oil from the shock absorber onto a cloth.
- Videz l'huile de l'amortisseur sur un chiffon.
- Lassen Sie das Öl aus dem Stoßdämpfer auf ein Tuch ablaufen.
- Giet de olie uit de schokdemper op een doek.

• Fill the shock absorber with new silicone shock absorber oil. FRONT & REAR = Shock Oil - Ultra Pure Silicone - 500 CPS

• Remplissez l'amortisseur avec de la nouvelle huile silicone pour amortisseur. AVANT & ARRIERE = Huile Silicone Ultra Pure - Amortisseurs - 500CPS.

• Füllen Sie den Stoßdämpfer mit neuem Silikonöl für Stoßdämpfer. VORNE & HINTEN: Ultra-reines Silikonöl – Stoßdämpfer – 500 CPS.

• Vul de schokdemper met nieuwe siliconenolie voor schokdempers. VOOR & ACHTER: Ultra Pure siliconenolie - Schokdempers - 500CPS.



# C-81250

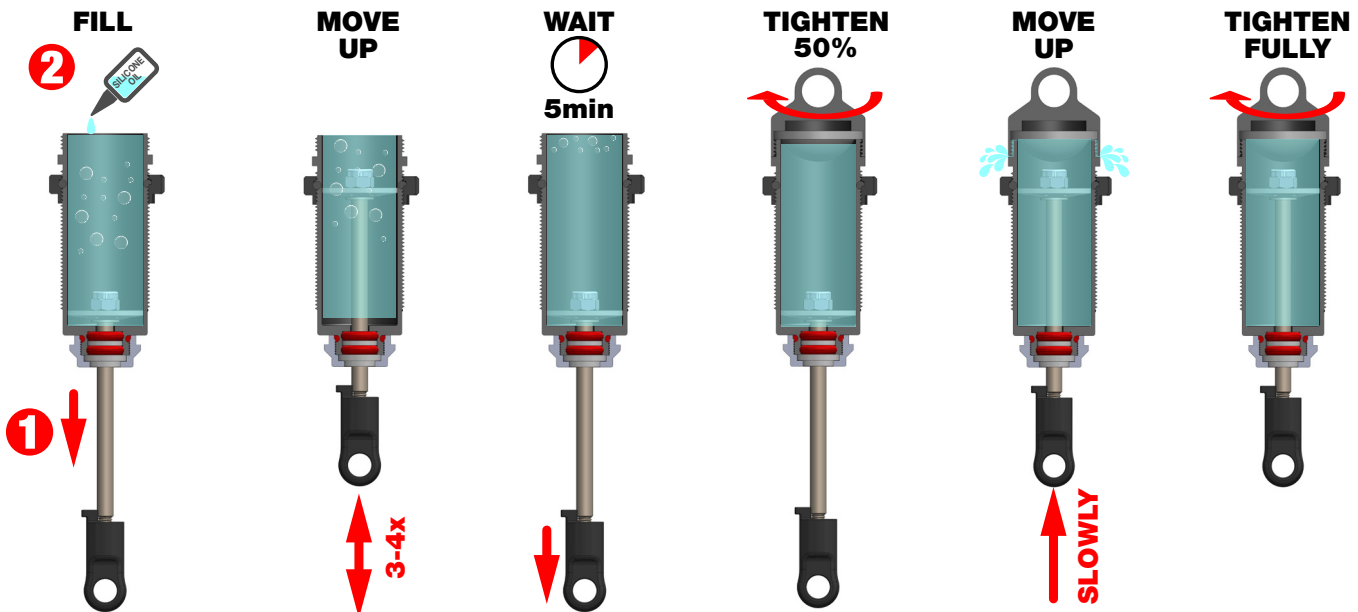

- Pull the shock shaft downwards. Fill the shock with silicone oil.
- Tirez l'axe d'amortisseur vers le bas. Remplissez l'amortisseur avec de l'huile de silicone.
- Ziehen Sie die Stoßdämpferachse nach unten. Füllen Sie den Dämpfer mit Silikonöl.
- Trek de schokdempers naar beneden. Vul de schokdemper met siliconenolie.
- Move the piston up&down (3-4x) to release the air bubbles in the silicone oil.
- Déplacez le piston de haut en bas (3-4x) pour libérer les bulles d'air.
- Bewegen Sie den Kolben nach oben&unten (3-4x), um die Luftblasen abzulassen.
- Beweeg de zuiger op en neer (3-4x) om de luchtbel-len te laten ontsnappen.
- Pull the Shock shaft down and wait until the bubbles rise to the surface.
- Tirez la tige d'amortisseur vers le bas et attendez que les bulles remontent à la surface.
- Ziehen Sie die Schockwelle nach unten und warten Sie, bis die Blasen an die Oberfläche steigen.
- Trek de Schokas naar beneden en wacht tot de luchtballen naar de oppervlakte stijgen.
- Screw in the shock absorber cap at 50%.
- Vissez le bouchon d'amortisseur à 50%
- Schrauben Sie die Stoßdämpferkappe zu 50 % ein.
- Schroef de dop van de schokdemper op 50%.
- Gently move the piston in upper position, the oil excess will flow out.
- Déplacez doucement le piston en position haute, l'excédent d'huile s'écoulera.
- Bewegen Sie den Kolben vorsichtig in die obere Position, das überschüssige Öl fließt dann heraus.
- Beweeg de piston langzaam in de bovenste positie, de overtollige olie zal eruit stromen.
- Now tighten the cap fully but not too much otherwise the membrane will be deformed.
- Maintenant, serrez le bouchon à fond, mais pas trop, sinon la membrane sera déformée.
- Ziehen Sie nun die Kappe vollständig, aber nicht zu fest an, da sonst die Membran verformt wird.
- Draai nu de dop helemaal vast, maar niet te vast, anders wordt het membraan vervormd.



## MOTOR REMOVAL - Démontage du moteur - Ausbau des Motors - Demontage van de motor

Follow the steps if you need to remove the motor.

Voici les étapes à suivre si vous devez démonter le moteur.

Hier sind die Schritte, die Sie befolgen müssen, wenn Sie den Motor ausbauen müssen.

Hieronder vindt u de stappen die u moet volgen als u de motor moet demonteren.

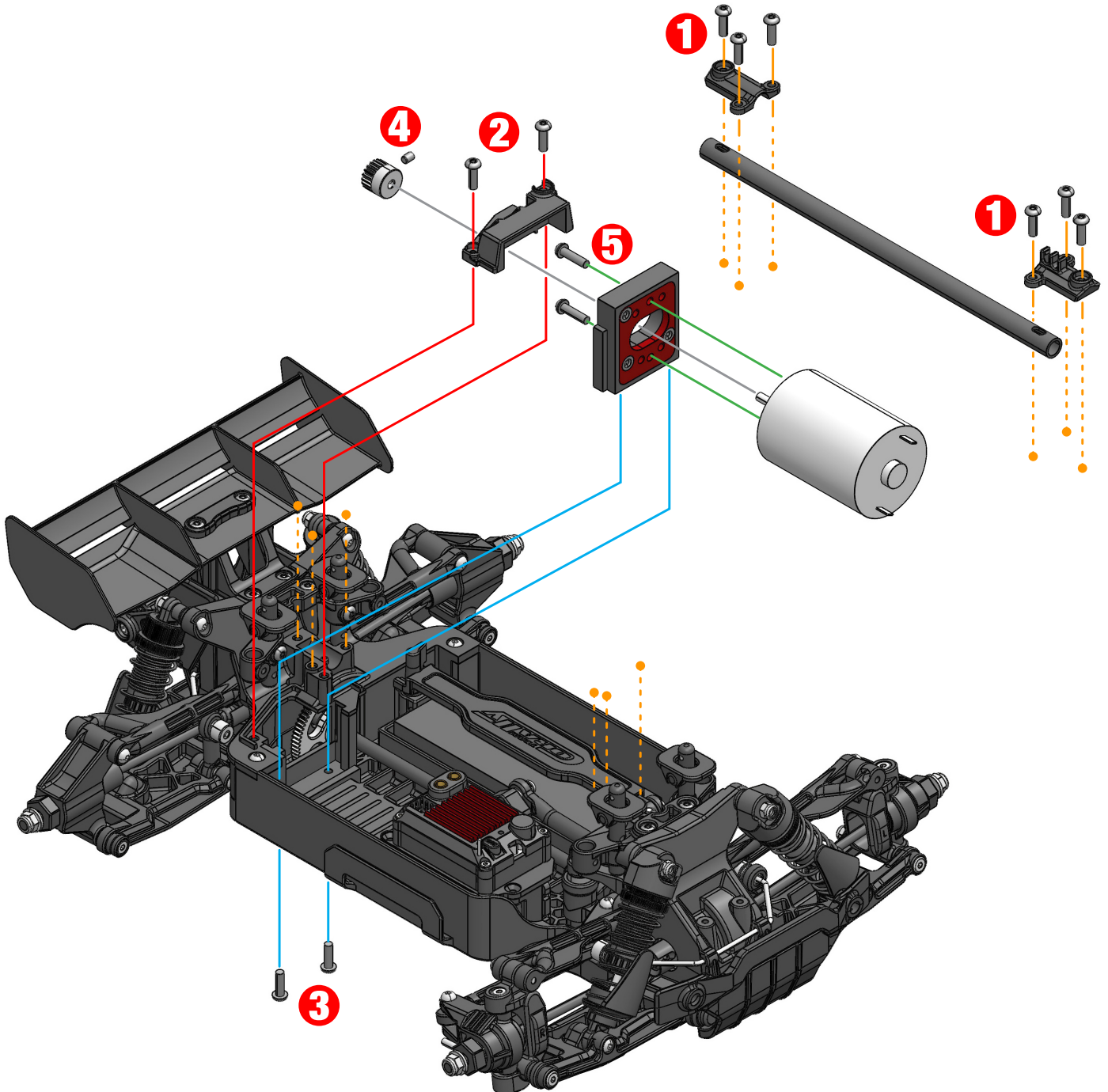



**FR&RE DIFFERENTIAL- Différentiel AV&AR - Vorder- und Hinterachsdifferenzial - Voor- en achterdifferentieel**

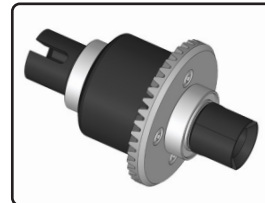
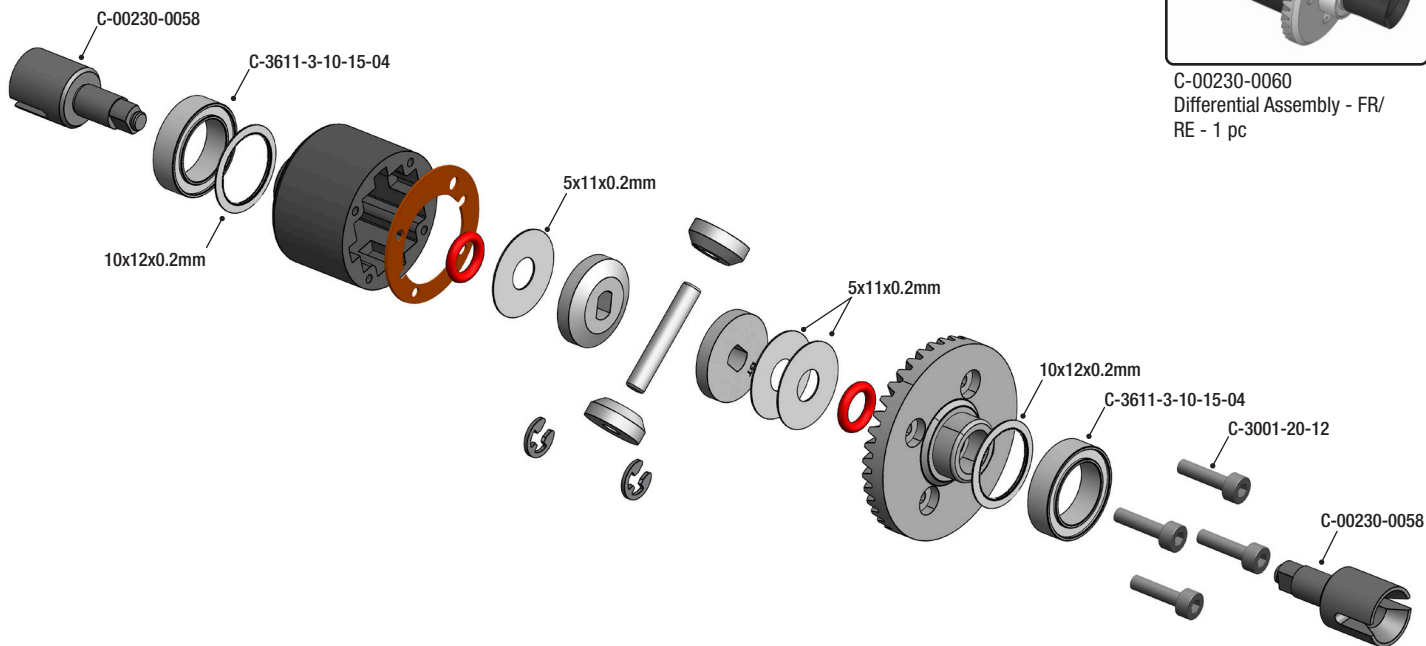

C-00230-0060  
Differential Assembly - FR/  
RE - 1 pc

**For differential maintenance; follow the steps below.**  
*Pour l'entretien différentiel, suivez les étapes ci-dessous.*  
 Für die Wartung des Differentials gehen Sie wie folgt vor.  
 Voor differentieelonderhoud; volg de onderstaande stappen.

**C-82702**  
Blue Grease 40gr



**Apply Grease**  
 Appliquer de la graisse.  
 Schmierfett auftragen.  
 Vet aanbrengen.

**C-82700**  
Lithium Grease 40gr



**Apply Grease**  
 Appliquer de la graisse.  
 Schmierfett auftragen.  
 Vet aanbrengen.

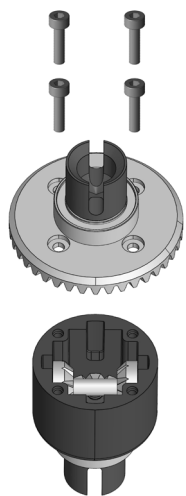

**1**



**2**

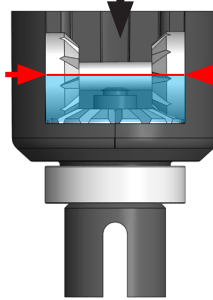

**3**

**50%  
CAPACITY MAX.**

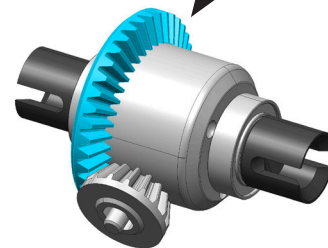

**4**





# EXPLODED VIEW

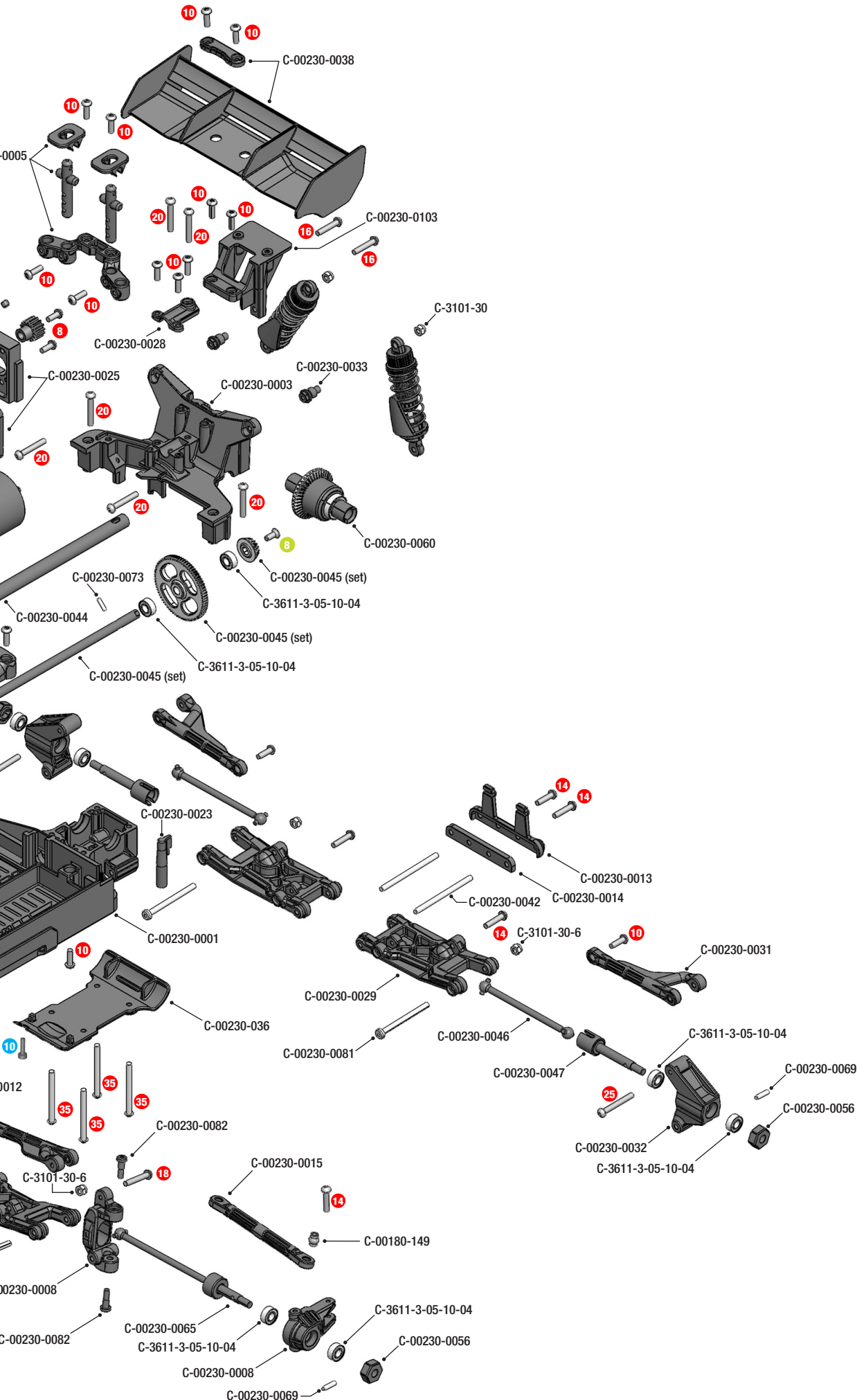

**HEX BUTTON HEAD SCREWS**  
DIN 7380 - STEEL - 10 PCS

- 8 M3x8mm #C-3003-30-08
- 10 M3x10mm #C-3003-30-10
- 12 M3x12mm #C-3003-30-12
- 14 M3x14mm #C-3003-30-14
- 16 M3x16mm #C-3003-30-16
- 20 M3x20mm #C-3003-30-20
- 25 M3x25mm #C-3003-30-25
- 30 M3x30mm #C-3003-30-30
- 35 M3x35mm #C-3003-30-35

**HEX FLAT HEAD SCREWS**  
DIN 7991 - STEEL - 10 PCS

- 6 M3x6mm #C-3002-30-06
- 8 M3x8mm #C-3002-30-08
- 12 M3x12mm #C-3002-30-12

**HEX SOCKET HEAD SCREWS**  
DIN 912 - STEEL - 10 PCS

- 10 M3x10mm #C-3001-30-10

**HEX SET SCREWS**  
DIN 916 - STEEL - 10 PCS

- 4 M3x4mm #C-3004-30-04



**SPARE PARTS**



C-00180-149  
Ball - 5.8mm - Steel - 4 pcs



C-00180-171  
Threaded Ball - 6mm - Steel - 2 pcs

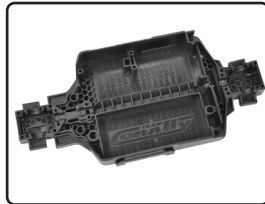

C-00230-0001  
Chassis - Composite - 1 pc



C-00230-0002  
Shock Tower - Cover - Front - 1 pc



C-00230-0003  
Shock Tower - Cover - Rear - 1 pc



C-00230-0005  
Body Mount Set - 1 Set

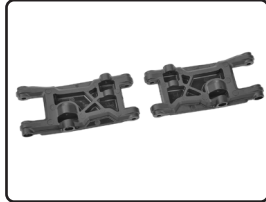

C-00230-0006  
Suspension Arm - Lower - Front - L/R - 1 pair



C-00230-0008  
Steering Knuckle - C-Hub - L/R - 1 pair



C-00230-0012  
Suspension Arm - Upper - Front - Composite - 2 pcs



C-00230-0013  
Suspension Arm Mount Cover - FR/RE - 1 Set

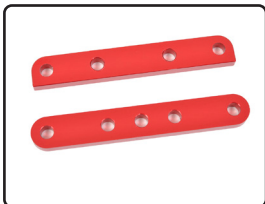

C-00230-0014  
Suspension Arm Mount - FR/RE - Aluminium - 1 Set



C-00230-0015  
Steering Links - 1 Set



C-00230-0017  
Servo Saver - Ackerman Plate - 1 Set



C-00230-0021  
Servo Saver Post - Steel - 2 pcs



C-00230-0023  
Battery Holder Mount - 1 Set



C-00230-0025  
Motor Mount - Composite / Aluminium - 1 Set

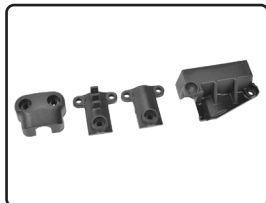

C-00230-0028  
Chassis Covers - 1 Set

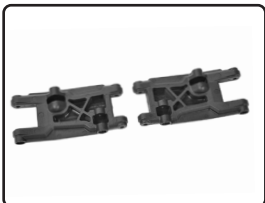

C-00230-0029  
Suspension Arm - Lower - Rear - L/R - 1 Pair



C-00230-0031  
Upper Arm Link - Rear - 2 pcs



C-00230-0032  
Wheel Hub - Rear - 2 pcs

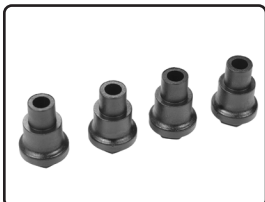

C-00230-0033  
Shock Spacer - Composite - 4 pcs



C-00230-0034  
Bumper - Skid Plate - Front - 1 pc



C-00230-0036  
Bumper - Skid Plate - Rear - 1 pc



C-00230-0038  
Wing - Holder plate - 1 Set

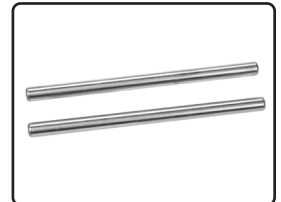

C-00230-0042  
Suspension Arm Pivot Pin - Rear - 47mm - Ø3mm - Steel - 4 pcs

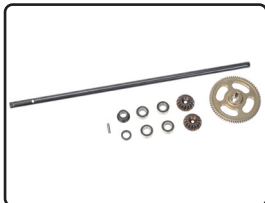

C-00230-0045  
Center Drive Shaft Assembly - 1 Set

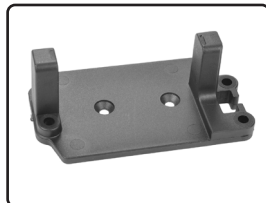

C-00230-0043  
Servo / ESC Mounting Plate - 1 pc



C-00230-0044  
Chassis Tube - Aluminium - 1 pc



C-00230-0046  
Dogbones - Rear - 64mm - 2 pcs



C-00230-0047  
Drive axle - Rear - 2 pcs



C-00230-0048  
Wheelie Bar Set - 1 Set



C-00230-0050  
Shock Cap - Shock Cap protector - 2 pcs



C-00230-0052  
Shock Absorber - Ready Build - with Silicone Oil - 2 pcs

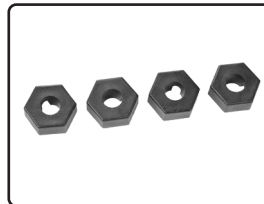

C-00230-0056  
Wheel Hex Adapter - 4 pcs



C-00230-0058  
Diff Outdrive Cup - Steel - 2 pcs

**SPARE PARTS**

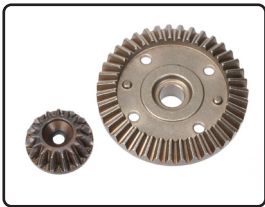

C-00230-0059  
Diff Bevel Gear Set - Molded Steel - 1 Set



C-00230-0060  
Differential Assembly - FR/RE - 1 pc



C-00230-0065  
CVD Drive Shaft - Front - 2 pcs



C-00230-0069  
Pin 2.5x10mm - Steel - 4 pcs



C-00230-0070  
Tire set Glued on Black Rims - 1 pair



C-00230-0081  
Hinge Pin - Outer - Steel - 2 pcs



C-00230-0082  
Hinge Pin Screw - Steel - 4 pcs



C-00230-0102  
Servo Saver Tube + Nut + Spring - Aluminium - 1 set



C-00230-0103  
Wing Mount - Composite - 1 pc

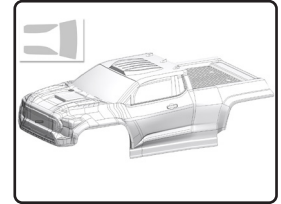

C-00230-0096  
Polycarbonate Body - Furago XD - Clear - Cut - Roof Skids



C-00230-0096-B  
Furago XD - Painted - Cut - Decals - Blue Color - 1 Pc

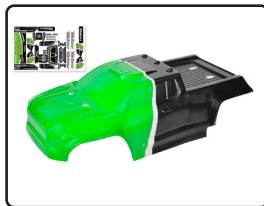

C-00230-0096-G  
Furago XD - Painted - Cut - Decals - Green Color - 1 Pc



C-00230-0096-O  
Furago XD - Painted - Cut - Decals - Orange Color - 1 Pc



C-00230-0096-R  
Furago XD - Painted - Cut - Decals - Red Color - 1 Pc

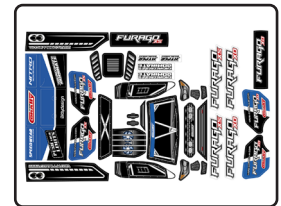

C-00230-0096-1  
Body Decal Sheet - Furago XD - Pre-Cut - Blue Color - 1 Pc

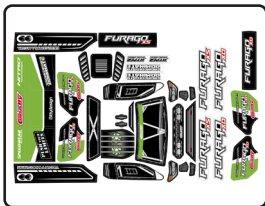

C-00230-0096-2  
Body Decal Sheet - Furago XD - Pre-Cut - Green Color - 1 Pc

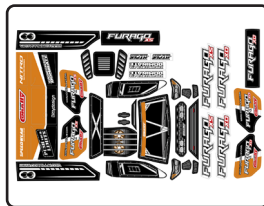

C-00230-0096-3  
Body Decal Sheet - Furago XD - Pre-Cut - Orange Color - 1 Pc

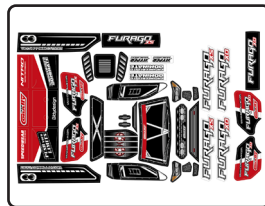

C-00230-0096-4  
Body Decal Sheet - Furago XD - Pre-Cut - Red Color - 1 Pc



C-00230-0126  
Motor pinion - 19T - Steel - 1 pc



C-00230-0127  
Motor Type - Brushed - 1 pc



C-00230-0128  
2in1 - ESC-Receiver - 1 pc



C-00230-0129  
Steering Servo - 1 pc



C-49402  
LiPo Battery 50C - 2500Mah - 2S - 7,4V - XT-60 - Hard Case



C-3611-3-05-10-04  
Ball Bearing - Abec 3 - 5x10x4 - 2 Pcs



C-3611-3-10-15-04  
Ball Bearing - Abec 3 - 10x15x4 - 2 Pcs

**Check the availability of spare & options parts in the "Car Spares - Tuning - RTR Series" section on [www.corally.com](http://www.corally.com).**



**DECLARATION OF CONFORMITY**

(in accordance with ISO/IEC 17050-1)

Description : **FURAGO XD - MONSTER TRUCK 4WD - 1/12 SCALE - RTR**  
Item Number: **C-00230**

This declaration is issued under the sole responsibility of the manufacturer.

Product : **FURAGO XD - MONSTER TRUCK 4WD - 1/12 SCALE - RTR**

The object of declaration described above is in conformity with the relevant Union harmonization Legislation, specifically the requirements of the specifications listed below, following the provisions of the European RED Directive 2014/53/EU:

EN 300 440 V2.1.1:2017	EN 301 489-3 V1.6.1:2013
EN 301 489-1 V2.1.1:2017	EN 60950-1:2006+A11:2009+A1:2010+A12:2011+A2:2013
EN 62479:2010	EN 55024:2010+A1:2015
EN 55032:2015	EN 61000-3-3:2013
EN 61000-3-2:2014	

Signed for and on behalf of : **JSP GROUP INTL • Geelseweg, 80 • 2250 Olen • Belgium**

Place and Date : **Olen, Belgium, 14 January 2026**

Name: **Stefan Engelen**  
Title : **Ceo**

Signature :



**FCC FEDERAL COMMUNICATIONS COMMISSION**

EQUIPMENT AUTHORIZATION is hereby issued to the named GRANTEE **JSP GROUP INTL BVBA / CORALLY**, and is VALID ONLY for the equipment identified hereon for use under the Commission's Rules and Regulations listed below.

FCC IDENTIFIER :	<b>2ASZJ-C59065</b>
Name of Grantee :	<b>JSP GROUP INTL BVBA / CORALLY</b>
Equipment Class :	<b>Part 15 Low Power Communication Device Transmitter</b>
Notes :	<b>Corally CT-2-S</b>
FCC Rules :	<b>15C</b>
Frequency Range (MHZ) :	<b>2410.0 - 2480.0</b>

## WARRANTY

If material defects or manufacturing faults should arise in a product distributed or manufactured by Team Corally / JSP Group Intl bvba, and purchased by a consumer, we Team Corally / JSP Group Intl bvba acknowledge the obligation to correct those faults or defects within the limitations described below. This manufacturer's warranty is in addition to, and does not affect, the legal or contractual rights of the consumer which arise from the purchase of such products. Team Corally / JSP Group Intl bvba guarantees the consumer that its products are free from material, manufacturing, and construction faults, as determined by the general state of knowledge and technology valid at the time of manufacturing. The fault responsible for causing the damage must be proven to have been present in the product at this time. Claims for compensation arising from consequential damage or product liability will not be considered valid unless they fall under peremptory provisions of the law. If material defects or manufacturing faults should arise in a product distributed or manufactured by Team Corally / JSP Group Intl bvba in the European community (EC) and purchased by a consumer, then Team Corally / JSP Group Intl bvba undertakes to correct those defects within the limitations described below. This manufacturer's declaration does not affect the consumer's legal or contractual rights regarding defects arising from the purchase contract between the consumer and the dealer or reseller. **Extend of the Warranty**

If a claim is made under warranty, we take at our discretion to repair or replace the defective goods. We will not consider supplementary claims, especially for reimbursement of costs relating to the defect (e.g. installation / removal costs) and compensation for consequent damages unless they are allowed by statute. This does not affect claims on legal regulations, especially according to the product liability law.

### Provisions of the Warranty

The purchaser is required to make the warranty claim in writing, and must enclose original proof of purchase (e.g. invoice, receipt, delivery note) and the appropriate warranty card. He must send the defective goods to our local representatives or directly to Team Corally / JSP Group Intl bvba, Geelseweg 80, 2250 Olen, Belgium at his own risk and cost. The purchaser should state the material defect or manufacturing fault, or symptoms of the fault, as accurate as possible, so that we can check if our warranty obligation is applicable. The goods are transported from the consumer to us, and from us to the consumer, entirely at the risk and cost of the consumer.

### Invalidation of the Warranty

The consumer cannot make a claim under warranty when the fault is affecting the use of the product arising from natural wear, competition use, or improper use (including installation) or external forces. The consumer's adherence to the building and operating instructions relevant to the model, including the installation, operation, use of, and maintenance of, model-related components cannot be supervised by Team Corally / JSP Group Intl bvba. Therefore Team Corally / JSP Group Intl bvba is in no way liable for loss, damage, or costs resulting from improper use, or behaviour in any way connected to the above described provisions. Unless otherwise required by law, Team Corally / JSP Group Intl bvba is in no way whatever liable to provide compensation for damages arising from the improper use of the model (including personal injury, death, damage to buildings, loss of turnover, loss of business, or interruption of business, or any other direct, or indirectly caused, consequential damage).

### Duration of Validity

The claim period is 24 months from the date of purchase of the product by the consumer from a dealer in the European Community (EC) counted from the date of purchase. The claim period is 12 months from the date of purchase of the product by the consumer from a dealer outside the European Community (EC) counted from the date of purchase. If a defect arises after the end of the claim period, or if evidence or documents required according to this declaration in order to make the claim valid are not presented until after this period, then the consumer forfeits any rights or claims from this declaration. The guarantee period is not prolonged by the granting of any claims within the framework of this warranty, especially in the case of repair or replacement. The guarantee period also does not restart in such cases.

### Warranty Expiration

If we do not acknowledge the validity of a claim based on this declaration within the claim period, all claims based on this declaration will expire after six months from the time of registering the claim; however this cannot occur prior to the end of the claim period.

For any support, contact us at [support.corally.com](https://support.corally.com)

## OTHER LANGUAGES

- Download the safety instructions and warranty in other languages here.
- Téléchargez les consignes de sécurité et garantie en dans les autres langues ici.
- Laden Sie die Sicherheitshinweise und Garantie in anderen Sprachen hier herunter.
- Download hier de veiligheidsinstructies en garantie in andere talen.



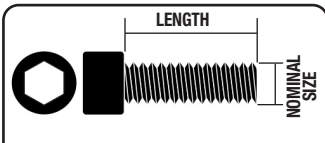

**HEX SOCKET HEAD SCREWS  
DIN 912 - STEEL - 10 PCS**

REF	NOMINAL SIZE	LENGTH MM
C-3001-16-06	M1.6	6
C-3001-20-04	M2	4
C-3001-20-06	M2	6
C-3001-20-08	M2	8
C-3001-20-10	M2	10
C-3001-20-12	M2	12
C-3001-20-16	M2	16
C-3001-25-06	M2.5	6
C-3001-25-08	M2.5	8
C-3001-25-10	M2.5	10
C-3001-25-12	M2.5	12
C-3001-25-16	M2.5	16
C-3001-25-20	M2.5	20
C-3001-30-06	M3	6
C-3001-30-08	M3	8
C-3001-30-10	M3	10
C-3001-30-12	M3	12
C-3001-30-14	M3	14
C-3001-30-16	M3	16
C-3001-30-20	M3	20
C-3001-30-25	M3	25
C-3001-30-30	M3	30
C-3001-40-06	M4	6
C-3001-40-08	M4	8
C-3001-40-10	M4	10
C-3001-40-12	M4	12
C-3001-40-14	M4	14
C-3001-40-16	M4	16
C-3001-40-18	M4	18
C-3001-40-20	M4	20
C-3001-40-22	M4	22

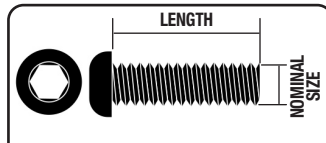

**HEX BUTTON HEAD SCREWS  
DIN 7380 - STEEL - 10 PCS**

REF	NOMINAL SIZE	LENGTH MM
C-3003-25-04	M2.5	4
C-3003-25-06	M2.5	6
C-3003-25-08	M2.5	8
C-3003-25-18	M2.5	18
C-3003-30-06	M3	6
C-3003-30-08	M3	8
C-3003-30-10	M3	10
C-3003-30-12	M3	12
C-3003-30-14	M3	14
C-3003-30-16	M3	16
C-3003-30-18	M3	18
C-3003-30-20	M3	20
C-3003-30-23	M3	23
C-3003-30-25	M3	25
C-3003-30-28	M3	28
C-3003-30-30	M3	30
C-3003-30-35	M3	35
C-3003-30-40	M3	40
C-3003-40-06	M4	6
C-3003-40-08	M4	8
C-3003-40-10	M4	10
C-3003-40-12	M4	12
C-3003-40-16	M4	16
C-3003-40-20	M4	20
C-3003-40-25	M4	25

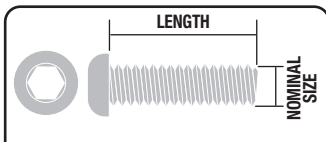

**HEX BUTTON HEAD SCREWS  
TITANIUM - 10 PCS**

REF	NOMINAL SIZE	LENGTH MM
C-3023-30-06	M3	6
C-3023-30-08	M3	8
C-3023-30-10	M3	10
C-3023-30-12	M3	12
C-3023-30-16	M3	16
C-3023-30-20	M3	20
C-3023-30-25	M3	25
C-3023-40-06	M4	6
C-3023-40-08	M4	8
C-3023-40-10	M4	10
C-3023-40-12	M4	12
C-3023-40-16	M4	16
C-3023-40-20	M4	20
C-3023-40-25	M4	25

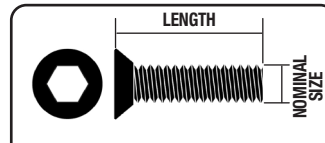

**HEX FLAT HEAD SCREWS  
DIN 7991 - STEEL - 10 PCS**

REF	NOMINAL SIZE	LENGTH MM
C-3002-25-08	M2.5	8
C-3002-30-06	M3	6
C-3002-30-08	M3	8
C-3002-30-10	M3	10
C-3002-30-12	M3	12
C-3002-30-14	M3	14
C-3002-30-15	M3	15
C-3002-30-16	M3	16
C-3002-30-18	M3	18
C-3002-30-20	M3	20
C-3002-40-06	M4	6
C-3002-40-08	M4	8
C-3002-40-10	M4	10
C-3002-40-12	M4	12
C-3002-40-14	M4	14
C-3002-40-16	M4	16
C-3002-40-18	M4	18
C-3002-40-20	M4	20
C-3002-40-25	M4	25

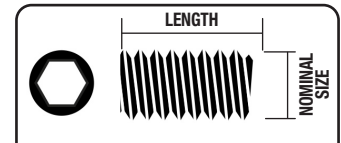

**HEX SET SCREWS  
DIN 916 - STEEL - 10 PCS**

REF	NOMINAL SIZE	LENGTH MM
C-3004-25-03	M2.5	3
C-3004-30-03	M3	3
C-3004-30-05	M3	5
C-3004-30-08	M3	8
C-3004-30-10	M3	10
C-3004-30-12	M3	12
C-3004-30-20	M3	20
C-3004-40-04	M4	4
C-3004-40-06	M4	6
C-3004-40-08	M4	8
C-3004-40-10	M4	10
C-3004-40-12	M4	12
C-3004-50-05	M5	5

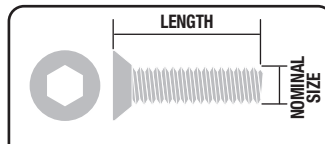

**HEX FLAT HEAD SCREWS  
TITANIUM - 10 PCS**

REF	NOMINAL SIZE	LENGTH MM
C-3022-30-06	M3	6
C-3022-30-08	M3	8
C-3022-30-10	M3	10
C-3022-30-12	M3	12
C-3022-30-16	M3	16
C-3022-30-20	M3	20
C-3022-40-08	M4	8
C-3022-40-10	M4	10
C-3022-40-12	M4	12
C-3022-40-16	M4	16
C-3002-40-20	M4	20

# NUTS

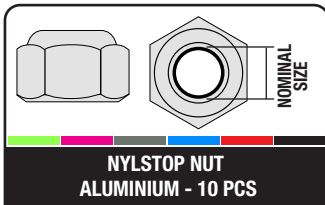

REF	NOMINAL SIZE	COLOR
C-3106-20-0	M2	Gold
C-3106-20-1	M2	Green
C-3106-20-2	M2	Purple
C-3106-20-3	M2	Gun
C-3106-20-4	M2	Blue
C-3106-20-5	M2	Red
C-3106-20-6	M2	Black
C-3106-30-0	M3	Gold
C-3106-30-1	M3	Green
C-3106-30-2	M3	Purple
C-3106-30-3	M3	Gun
C-3106-30-4	M3	Blue
C-3106-30-5	M3	Red
C-3106-30-6	M3	Black
C-3106-40-0	M4	Gold
C-3106-40-1	M4	Green
C-3106-40-2	M4	Purple
C-3106-40-3	M4	Gun
C-3106-40-4	M4	Blue
C-3106-40-5	M4	Red
C-3106-40-6	M4	Black
C-3106-50-0	M5	Gold
C-3106-50-1	M5	Green
C-3106-50-2	M5	Purple
C-3106-50-3	M5	Gun
C-3106-50-4	M5	Blue
C-3106-50-5	M5	Red
C-3106-50-6	M5	Black

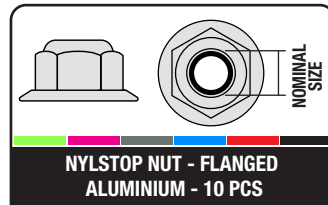

REF	NOMINAL SIZE	COLOR
C-3107-30-0	M3	Gold
C-3107-30-1	M3	Green
C-3107-30-2	M3	Purple
C-3107-30-3	M3	Gun
C-3107-30-4	M3	Blue
C-3107-30-5	M3	Red
C-3107-30-6	M3	Black
C-3107-40-0	M4	Gold
C-3107-40-1	M4	Green
C-3107-40-2	M4	Purple
C-3107-40-3	M4	Gun
C-3107-40-4	M4	Blue
C-3107-40-5	M4	Red
C-3107-40-6	M4	Black
C-3107-50-0	M5	Gold
C-3107-50-1	M5	Green
C-3107-50-2	M5	Purple
C-3107-50-3	M5	Gun
C-3107-50-4	M5	Blue
C-3107-50-5	M5	Red
C-3107-50-6	M5	Black

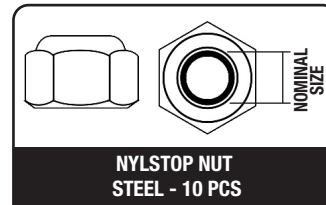

REF	NOMINAL SIZE	COLOR
C-3101-20-6	M2	Black
C-3101-25	M2.5	Silver
C-3101-25-6	M2.5	Black
C-3101-30	M3	Silver
C-3101-30-6	M3	Black
C-3101-40	M4	Silver
C-3101-40-6	M4	Black

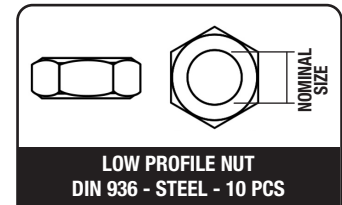

REF	NOMINAL SIZE	COLOR
C-3104-40	M4	Silver
C-3104-50	M5	Silver

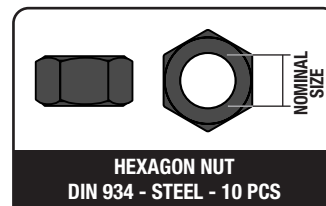

REF	NOMINAL SIZE	COLOR
C-3103-20-6	M2	Black
C-3103-25-6	M2.5	Black
C-3103-30-6	M3	Black
C-3103-40-6	M4	Black
C-3103-50-6	M5	Black



 WEEE: At the end of this device's useful life, please remove all the batteries and dispose of them separately. Take electrical appliances to the local collection points for waste electrical and electronic equipment. Other components can be disposed of in domestic refuse. Thank you for your co-operation!

This manual is an edition of Corally, a division of JSP GROUP INTL BV, Geelseweg 80, B-2250 Olen, Belgium. This manual is protected by a copyright and nothing from this edition may be reproduced or used without any prior written authorisation. Whilst every effort has been made to ensure the accuracy of the information in this manual, errors creep in and Corally can accept no responsibility for failures, wrong specifications, accuracy of colours, losses or damages caused. Corally denies any responsibility claims or damages caused by use of our products.

Corally is not responsible for product / parts / specifications / Colour changes or availability of these products.



**WWW.CORALLY.COM**

**Team Corally is a registered trademark licensed to  
JSP Group Intl nv • Geelseweg 80 • B-2250 OLEN • Belgium  
Tel: +32 14 25 92 83 • support@corally.com**